



Let wood stay
where it belongs

Let wood stay
where it belongs

ACCUCEL

The Environment-friendly Alternative



Wood belongs outside your house

The few pieces of the interesting furniture at the cost of spoiling the nature's bounty.

This simple statistics may prove to be the eye opener. Out of the total trees cut for the wood, nearly 40 to 45% are used to make doors and windows; and 20 to 30% besides the normal firewood, go in the making of the furniture and other sundry uses!

The solution has been staring us in the eye, for sometime now. **Accucel from Accura Polytech** has been in the forefront of developing the alternative to the wood and today the steady growth of the company proves the proverb that the fortune favours the brave...

Accucel comes in varied range of dimensions, colors and can have multiple applications at homes, hotels, hospitals, offices, schools and any other space that you would care to design with care for nature.

Accucel offers practical solutions as it can be used by the regular carpenters with their usual skill and carpentry tools. Ready to use sections save their time also.

Characteristics

- ❖ Fine cellular foam structure
- ❖ Firm, smooth outer skin, 0.5 - 1.5 mm thickness
- ❖ Surfaces with silky gloss finish
- ❖ Homogeneously colored
- ❖ Fungus resistant
- ❖ Low density ranging b/w 0.5 - 0.8 g/cc
- ❖ Waterproof, termite proof

- ❖ Easy workability like wood
- ❖ UV stabilized, non dusting, non discoloring, long lasting
- ❖ Fire retardant, stain resistant, scratch resistant
- ❖ Excellent heat and sound insulation characteristics
- ❖ High impact strength
- ❖ Pre-finished on both sides



The laboratory of this huge breakthrough product is located at Ahmedabad and the factory premises hold the best of plant and machinery to actualize the dream of Mr. H R Shukla & Mr. Rasik Thakkar, who have been on a crusade since 1994 to come up with such specimen of perfect antidote to wood!

SAVE EARTH SAVE ENERGY...

From the raw material mixer to the extrusion of different sections, from fabrication of different end use products to transforming the building and furniture sector, it's one painstaking journey of the efforts of the technical team, the confidence of the management and a perfect product flowing out into different shapes and dimensions...

The competing products like aluminum, steel etc. are used as alternatives to wood in various new high rise buildings and industrial applications, but suffer from the inherent problem of being the good conductors of heat and thus use more energy. Comparatively, Accucel, being polymer based is bad conductor of heat and thus the doors and windows help mitigate the extreme heat and cold effects and even the production process itself is power saving.

Advantages :

- ❖ Light weight, high flexural strength, impact resistant
- ❖ Pre-finished surface makes it ready to use
- ❖ Smooth surface ideal for printing; can be painted/ coated/ laminated, if desired
- ❖ Can be nailed, screwed, drilled, glued, sawn, tapped, welded
- ❖ Can be easily bonded with PVC solvent based adhesives
- ❖ Low thermal conductivity
- ❖ Resistance to chemical substances and non corroding
- ❖ Low absorption of water, no rot
- ❖ Weatherproof and light fast
- ❖ Ready for indoor and outdoor use without pre-treatment
- ❖ Self extinguishing, fire retardant class I grade material
- ❖ Can be recycled which makes it environment-friendly

Application areas

Windows | Doors | Kitchen Cabinets | Wardrobes | Prefab Cabins | Schools, Offices and Hospital furniture



u PVC Windows

If the term practical magic intrigues you and fills you with anticipation, then open the window of your imagination and let the eco-friendly Accucel window frames & shutters sail in to your life.

Ease & Efficiency

Working with Accucel is like opening the window to multitudes of new applications, styles and designs while maintaining the practical applications that support the workmen, carpenters and conventional tools & machines. No heavy investment is needed for equipment for fabrication and the saving in energy is to be experienced to believe.

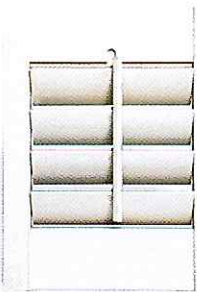

Be it the openable kinds or the stylish sliding & pivoted ones, practicality & aesthetics are well-maintained during their lifetime.

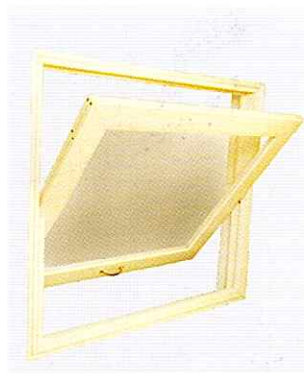



u PVC Doors

The door to a beautiful world, where the form and function work in perfect harmony, opens with the introduction of Accucel door shutters...

Be it the designer doors with aesthetic glass or grill, they glamorize every space they are part of and enable customization; the single panel and multi panel doors or the sandwiched doors with their space saving features, Accucel Multi-faceted doors have advantages galore.

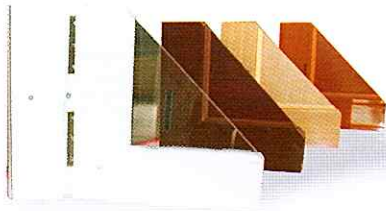



Kitchen Cabinet

Cooking a revolution in the Kitchen...

ACCUCEL kitchen cabinet shutters provide an opportunity to every architect, designer and builder, who desire the international class kitchens in Indian homes. Besides these obvious advantages, it does not form powdery effect experienced in wood or particle board.

Long life and permanent looks | Clean and hygienic | Water proof and Termite proof | Maintenance free

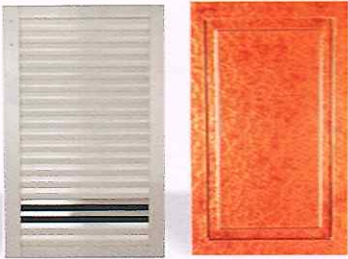

Options that spell opulence

- ❖ Design like Louvered, Diamonds, Raised panel - plain / arched, HPL sheet infill in wide range of decorative wood veneer, marble / granite finishes, PU coated glossy / semi glossy / matt or metallic & pearl finishes etched glass infill panel
- ❖ Can be made available in different sizes & colours

Wardrobe Shutter

Glamorous wardrobes to fit the requirements of the bedrooms, kids rooms etc. Can also be made to fit the internal space or covering the frame as per the design.



Railing / Fencing

Decking Flooring

Accucel Decking and Flooring offers an unparalleled aesthetic that can't be found in other decking material. High end looks with superior performance, for the wide colours, texture and grain pattern resembling the real wood without the maintenance cost in a variety of price points make Accucel upvc's Flooring a right choice of the astute home owners.

Accucel Decking and Flooring will not rot, crack, warp or splinter, doesn't require sanding, staining or sealing, giving you peace of mind and long lasting to show off your outdoor masterpiece.

Modernize your outdoor living space

Accucel innovative range of uPVC railing and Fencing systems is designed and manufactured with unparalleled attention to design, style and quality engineering. Providing the striking natural appearance of timber wood grains, our beautifully foiled fencing range offers a full range of gravel boards, posts, caps and utility strip with the range of beautiful colours while being a complete maintenance free.





Duct Cover

Accucel modular duct cover system has been designed and developed over years with a view to offer a range of buildings which can satisfy the requirements of many different end users application. Accucel duct cover creates a functional closed pace that is both pleasing to eye and environmentally sound.

Considering the above features, architects and designers find it easy to work out elevations matching to their dreams and performance criteria.

Trellis / Vinyl Lattice Cover

Accucel Vinyl Lattice is virtually maintenance free. In exterior locations subject to sun, rain and wind, Accucel VINYL Lattice is self cleaning and will look good for years. The surface looks like grainless wood with a satin coat of paint. It lasts a long time, easy to install. Because it never needs painting and is so long lasting it can cost LESS while looking better than even the finest quality wood lattice.

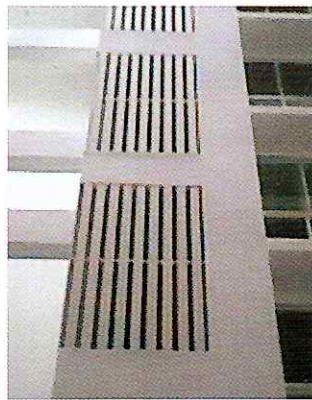



Louvered Windows

The innovative folding system for Traditional & Modern Design

Accucel Louvered shutter system that offers a wide range of uses : as a special accent on the House, as a screen from the prying eyes of the neighbor, as sun protection and to regulate the indoor climate. Visually harmonize the shutters innovative design with their variety of shapes and colours with each architecture.

Fascia Cladding

Accucel Duct cover can be used for fascia cladding, hiding water drainage/sewage ducts, protecting air conditioners and air ventilation, semi privacy for open balconies/ kitchen galleries etc. offering clean, flexible and efficient environment that will reflect the high standards of the user.

Accucel Fascia Cladding exists to meet the rapidly changing demands of modern society using Accucel Upvc foam profile.





SAVE OUR SOIL, PROSPER OUR FUTURE

Savadhyaar Bio Toilet

Today, world over, the most concerned issue talked about is the Global warming, promoting Organic Farming and Plantation for Green Revolution.

India is working towards the goal of Proper Sanitation to achieve open defecation free country.. Enztech Green Technologies has developed Innovative Enzymes Technology for the disposal of sewage waste and proper sanitation to achieve open defecation free India, public Hygiene/health and promote organic farming and plantation for Green Revolution as well as global warming solution improving social life of common man.

Objective :

- ❖ Eradication of Manual Scavenging
- ❖ Modern and Scientific Municipal Solid Waste Management
- ❖ To effect behavioural change regarding healthy Sanitation Practices
- ❖ Generate awareness about Sanitation and its linkage with public health
- ❖ Can earn sustainable sanitation by using Public Toilets as Hoarding/Advertising space.





False Ceiling

Wall Paneling

Imagine being enclosed by beautiful wooden walls but not being responsible for committing the sin of cutting the precious natural resource ! Accucel wall paneling solutions are every interior designer's delight.

Your true class reflects from your false ceiling...

Accucel False Ceiling

Let the world know that you care for the environment, that your taste is impeccable and you weigh the practical consideration as you dreamily look at the ceiling...

Made from Accucel solid PVC foam profiles with integral skin manufactured at a state of the art factory using hi-tech Italian technology, Accucel false ceiling provides the contrasting play of sturdy elegance.

Properties that perfect the science of technology & art of appearance...

The wall paneling and false ceiling are effective solutions for damp walls, besides having good acoustic properties. The installation is easy, maintenance almost nil.

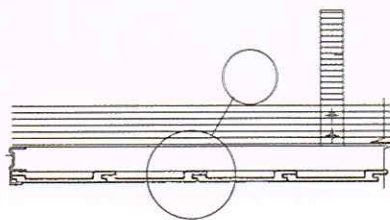
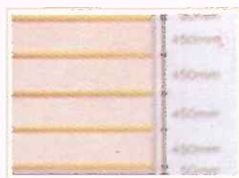
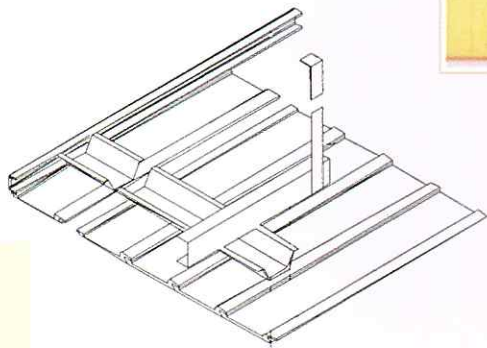



Prefab Structure

This one product combines the adventure of open lands and amenities of perfectly crafted closed spaces.

The modular structures made of PVC section are easy to install and re-organize according to the changing needs. They are low maintenance units with excellent weatherability.

Mobile toilets, temporary shelters etc. are fast gaining acceptability for prefab structures as the ideal choice.

The modular structures made of PVC section are easy to install and re-organize according to the changing needs. They are low maintenance units with excellent weatherability.





Applications

Site office | Vending kiosk for Tea / Coffee / News paper / Tickets / Flower / Gifts / Ice-cream / Perfumery / Green Grocers etc. | School, Restaurants | Providing clean & hygienic alternative to slums | Temp. Working space in restricted allowable FSI buildings on terrace | Traffic control / Toll collection booths | Information centers | Emergency accommodation for health units | Rehabilitation units for natural calamity affected areas | Temp. Toilets for exhibitions, conventions | Holiday resorts / Beach resorts / Farm houses | STD / PCO Booth | BTS container / Shelter for cellular phone operations | Security cabins

Salient Features

- ❖ Water proof / Termite proof
- ❖ Fire retardant
- ❖ Easy to relocate
- ❖ Energy efficient - heat & sound insulant
- ❖ Corrosion resistant
- ❖ Environment- friendly
- ❖ Earthquake resistant
- ❖ Unlimited configurations
- ❖ Light weight - easy to transport



Ready to use

Modular Furniture

With the changing times and growing consciousness for the natural resources, the furniture segment is fast adapting to the safe and superior Accucel.

A range of furniture can be there for

- ❖ Schools
- ❖ Hospitals
- ❖ Smart shoe racks & tray tables etc. for home and office needs
- ❖ Re-organizable and stately furniture for resorts and garden restaurants etc.





As the world is waking up to the terror of deforestation, it is the duty of every world citizen to be savvy and know the options available to make a difference.

Accucel has proved time and again that it has

- ❖ An innovative product in its arsenal
- ❖ The quality is practically unchallenged and proven
- ❖ The practical applications ensure that the product provides not only the substitute of wood but surpasses all the other alternatives

And being approved and accepted as a better alternative by these institutions of repute instills the sense of achievement in the world.

MES | CPWD | R & B Dept | Indian Railways | Defense authorities | ISRO | MHADA | AAI | CIDCO etc.; corporate and multinational companies like Reliance, Jindal, IIM, Prestige, Ansal, Nestle, Flamingo International etc.

Be the change you want around you...





ACCUCEL

The Environment-friendly Alternative

Accura Polytech Pvt. Ltd.

8, Ajithnath Society, Opp Paldi P.O. Ahmedabad - 380 007, Gujarat, INDIA.

Phone: + 91 - 79 - 26630154 | Telefax: + 91 - 79 - 26633668

E - mail : accucel@gmail.com | Website : www accurapolytech.com